

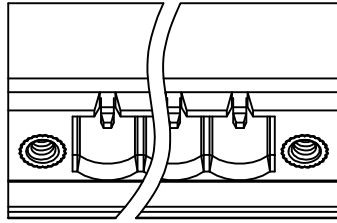



SIGN	DATE	DESCRIPTION	APPROVER
THIS IS CAD DRAWING, DO NOT REVISE MANUALLY!!!			



**Material**

- Contact pin: Brass
- Surface of solder tail: Tin plated
- Threaded Insert: Brass M2.5
- Insulator (housing): Thermoplastic (UL94V-0)

**Electrical cULus /VDE / TUV**

- Voltage rating: 300V/300V/300V
- Current rating: 15A/17A/20A
- Withstanding Voltage: 1.6KV/2.5KV/2.5KV
- Operating temperature: -30° C to +105° C
- Soldering temperature: 250° C ±10° C/5 Sec
- Safety Approval:   

RoHS Compliant

PART NUMBER:

**OSTVKXX5250**

No. of Poles	COLOR
02 2 Poles	0: Black
03 3 Poles	5: Green (Standard)
... ..	6: Blue
24 24 Poles	8: Grey

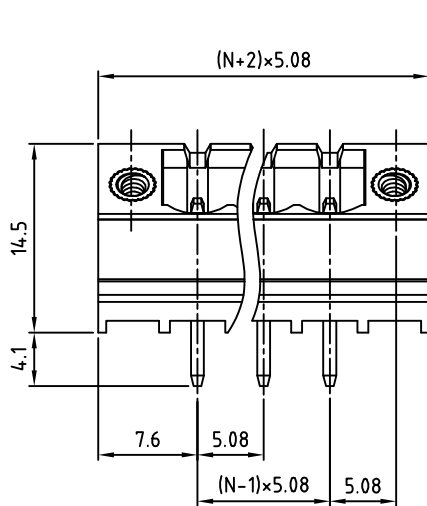

N=Number of contacts

**P.C.B LAYOUT**

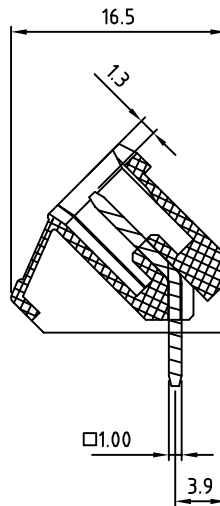
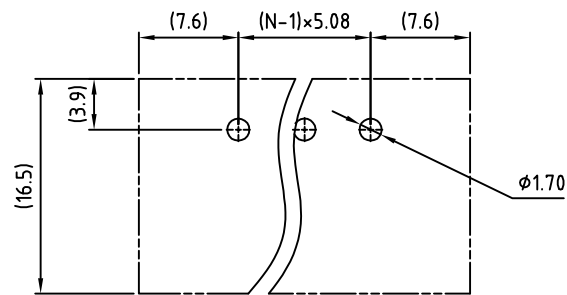

THESE DRAWINGS AND SPECIFICATIONS ARE THE PROPERTY OF ON-SHORE TECHNOLOGY, INC. AND SHALL NOT BE REPRODUCED, COPIED OR USED IN ANY MANNER WITHOUT THE PRIOR WRITTEN CONSENT OF ON-SHORE TECHNOLOGY, INC.



TITLE		OSTVK-5.08 Series 45D with flange 2p-24p			
PART NO.	OSTVKXX5250	DWG NO.	OSTVKXX5250.DWG		
APPROVED	CHECKED	DESIGNED	DRAWN	CUST NO.	Tolerance
Shi Jun 2006.10.23	Marvin 2006.10.23	Marvin 2006.10.23	Marvin 2006.10.23		X. ±0.50 X.X ±0.30 X.XX ±0.10 X° ±1°
SHEET: 01/01				REV.: D	UNIT: mm SCALE: NONE